

Instruction Manual

Installation • Operation • Maintenance

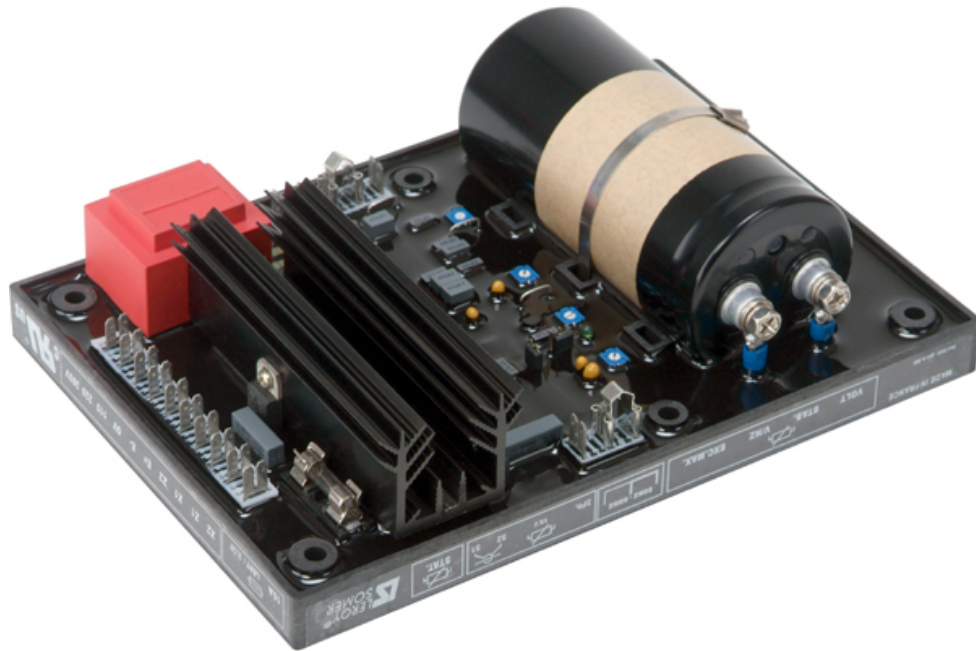

Voltage Regulator AVR R449

Ruitai industry Co.,Ltd.
Tel: +86 577 56784310
Fax: +86 577 56667563
Email: sales@china-avr.com
www.china-avr.com

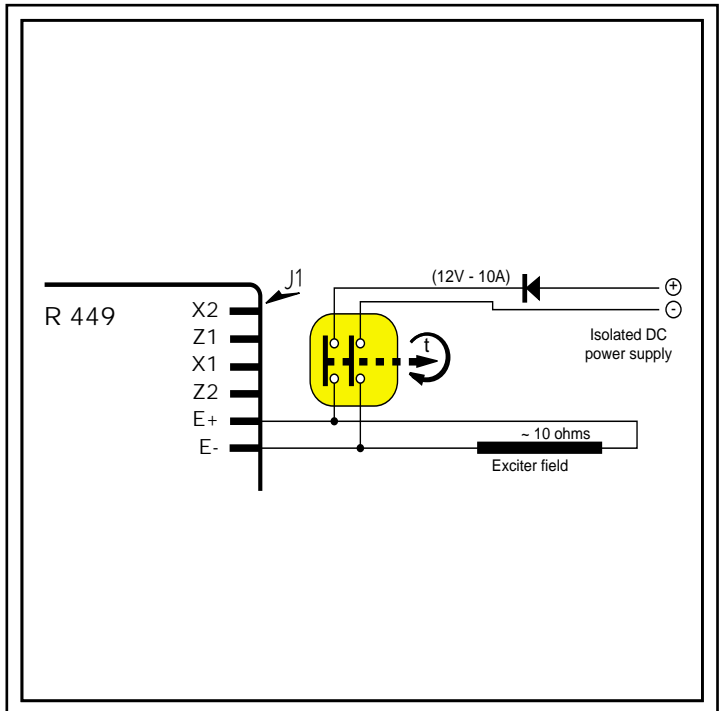
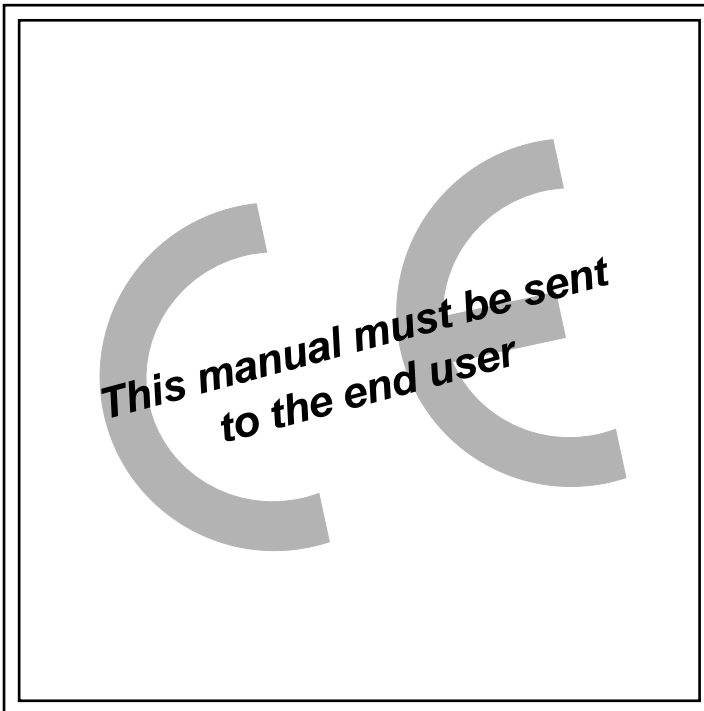
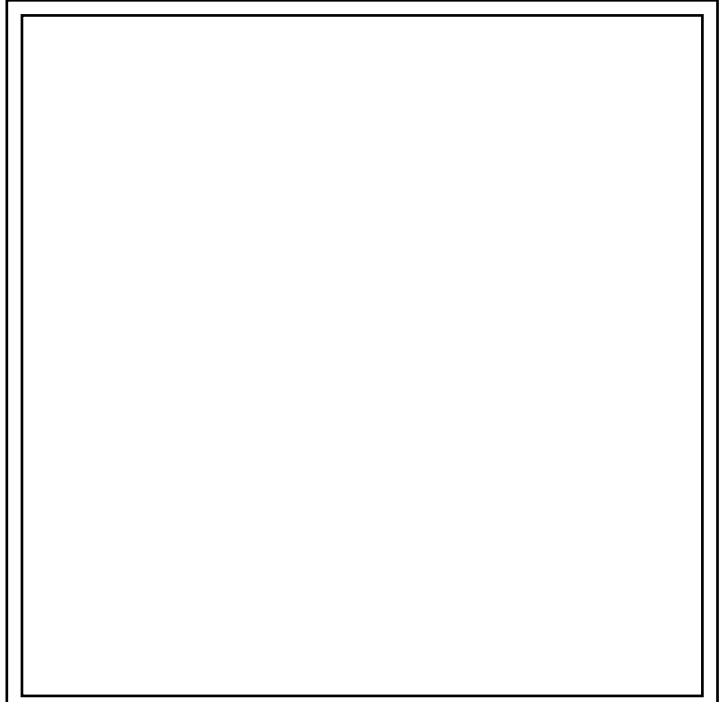
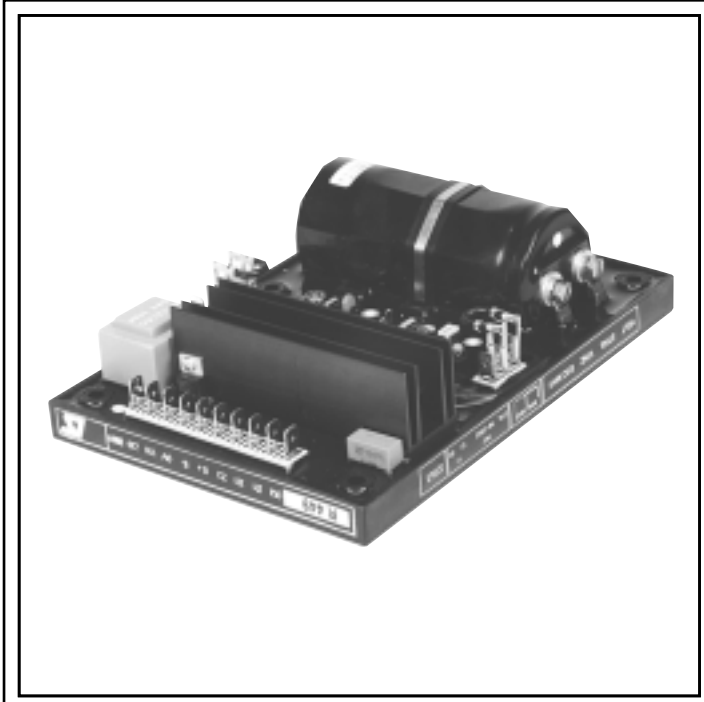

VOLTAGE REGULATOR

R 449

Installation and maintenance

VOLTAGE REGULATOR

R 449

WARNING

TO AVOID HARM EITHER TO PEOPLE OR TO THE INSTALLATION, THIS UNIT SHOULD ONLY BE COMMISSIONED BY QUALIFIED PERSONNEL.

CAUTION

DO NOT USE HIGH-VOLTAGE MEASURING APPARATUS. INCORRECT USE OF CERTAIN APPARATUS CAN CAUSE IRREPARABLE DAMAGE TO THE SEMICONDUCTORS INCORPORATED IN THE AVR.

NOTE

THE WIRING DIAGRAMS GIVEN IN THIS MANUAL ARE FOR INFORMATION ONLY. FOR THE CORRECT WIRING, SEE THE DIAGRAMS SUPPLIED WITH THE ALTERNATOR.

CAUTION

1) WHEN THE ALTERNATOR IS STOPPED, MAINS VOLTAGE MAY STILL BE PRESENT AT THE MODULE VOLTAGE SENSING TERMINALS.

DANGER OF DEATH

2) DO NOT PERFORM DIELECTRIC TESTS WITHOUT DISCONNECTING THE MODULE AND ASSOCIATED AVR.

RISK OF DESTRUCTION

VOLTAGE REGULATOR

R 449

TABLE OF CONTENTS

| | |
|--|-----------|
| 1 - Introduction to the R 449 | 4 |
| 1.1 - Application | 4 |
| 1.2 - Description | 4 |
| 1.3 - Electrical characteristics | 5 |
| 1.3.1 - Operating diagram | 5 |
| 1.3.2 - Detection | 6 |
| 1.3.3 - Voltage accuracy | 6 |
| 1.3.4 - Voltage adjustment | 6 |
| 1.3.5 - Power supply | 6 |
| 1.3.6 - Output power | 6 |
| 1.3.7 - Quadrature droop (1F) | 6 |
| 1.3.8 - Frequency/Underspeed | 6 |
| 1.3.9 - Stability | 8 |
| 1.3.10 - Limiting the excitation current I_{ex} | 8 |
| 1.3.11 - Protection | 8 |
| 1.3.12 - Voltage build-up | 8 |
| 1.3.13 - Power used | 8 |
| 1.3.14 - De-energising | 8 |
| 1.4 - Environment | 8 |
| 2 - R 726: Regulation of power factor (2F) and mains sensing (3F) | 9 |
| 2.1 - Operating diagram | 9 |
| 2.2 - Potentiometers | 10 |
| 3 - Typical diagrams | 11 |
| 3.1 - AREP 1F LV excitation | 11 |
| 3.2 - AREP 1F MV excitation | 12 |
| 3.3 - AREP 3F LV excitation | 13 |
| 3.4 - AREP 3F MV excitation | 14 |
| 3.5 - 1F LV shunt + booster excitation | 15 |
| 3.6 - 1F LV PMG excitation | 16 |
| 4 - Commissioning | 17 |
| 4.1 - In case of standalone regulation | 17 |
| 4.2 - In case of 1F regulation (parallel operation between alternators) | 17 |
| 4.3 - In case of 2F (power factor regulation) and 3F (voltage match circuit) | 17 |
| 5 - Troubleshooting | 18 |
| 5.1 - Checking the windings and rotating diodes using a separate excitation | 18 |
| 5.2 - Static checking of the regulator | 18 |
| 5.3 - Troubleshooting table | 19 |
| 5.3.1 - In case of 1F, parallel operation between alternators | 19 |
| 5.3.2 - In case of 2F and 3F | 21 |
| 5.3.3 - Checking the alternator using a separate excitation | 21 |
| 5.4 - Replacing the regulator with a spare voltage regulator | 21 |

VOLTAGE REGULATOR

R 449

INTRODUCTION TO THE R 449

1 - INTRODUCTION TO THE R 449

1.1 - application

The R 449 voltage regulator is of a shunt type. It is designed to fit as standard on A50 to A 54 alternators. It can be supplied with power either by a power VT, or by the AREP field excitation system, or by a single-phase or 3-phase PMG. Using the R 726 external module, the regulator can control the power factor (2F) and can match the alternator voltage to the mains voltage (3F) prior to synchronisation.

1.2 - description

The electronic components mounted in a plastic casing are sealed with opaque elastomer. Connection is via 2 connectors (male "Faston" lugs 6.3)

The regulator includes:

- A main terminal strip (10 terminals) J1
 - A secondary terminal block (5 terminals) J2
 - A frequency selection terminal block (3 terminals) J3
 - A quadrature droop potentiometer P1
 - A voltage potentiometer P2
 - A stability potentiometer P3
 - An underspeed potentiometer P4
 - A maximum excitation potentiometer P5
 - A sensing selection jumper ST1 (single/3-phase with an external module)
 - A response time jumper ST2
 - A frequency selection jumper ST3
 - An external voltage setting jumper ST4
 - A LAM (load adjustment module) jumper ST5
- From R449 Version E number 10,000, this jumper will be removable.

Two fuses (F1 and F2) are connected to this regulator; they are mounted in the alternator on terminal block C. Type: gG 10/38 16A 500V.

Simplified diagram of a potentiometer:

To adjust the potentiometer, check the actual position of the potentiometer stop.

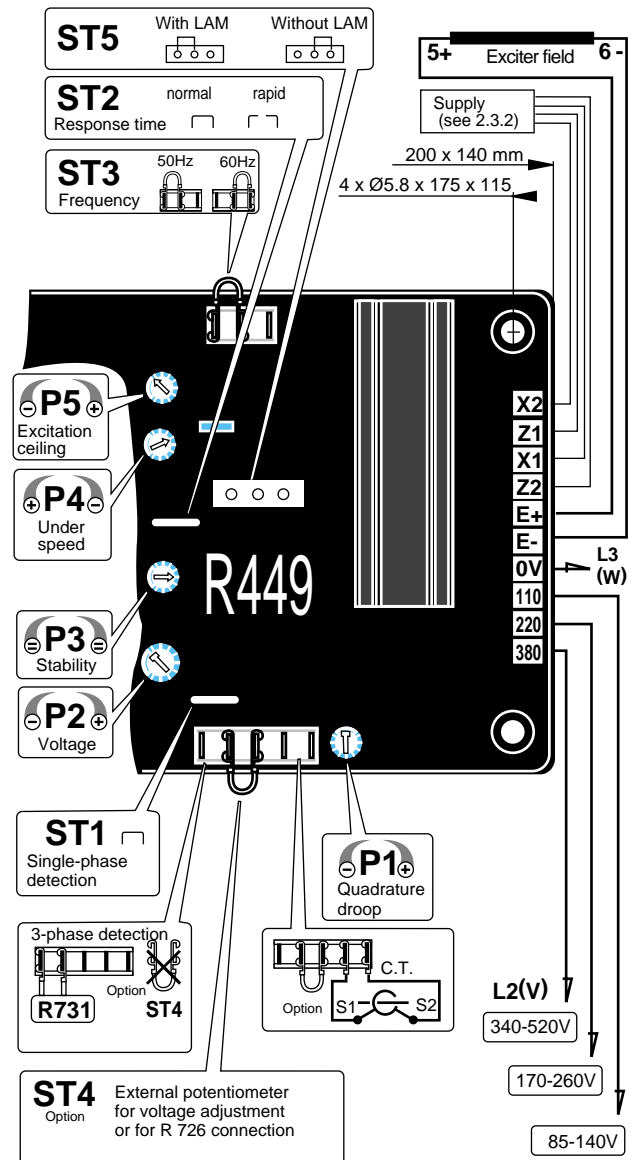
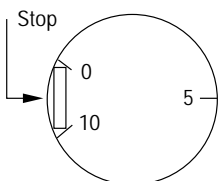

VOLTAGE REGULATOR

R 449

INTRODUCTION TO THE R 449

1.3 - electrical characteristics

1.3.1 - operating diagram

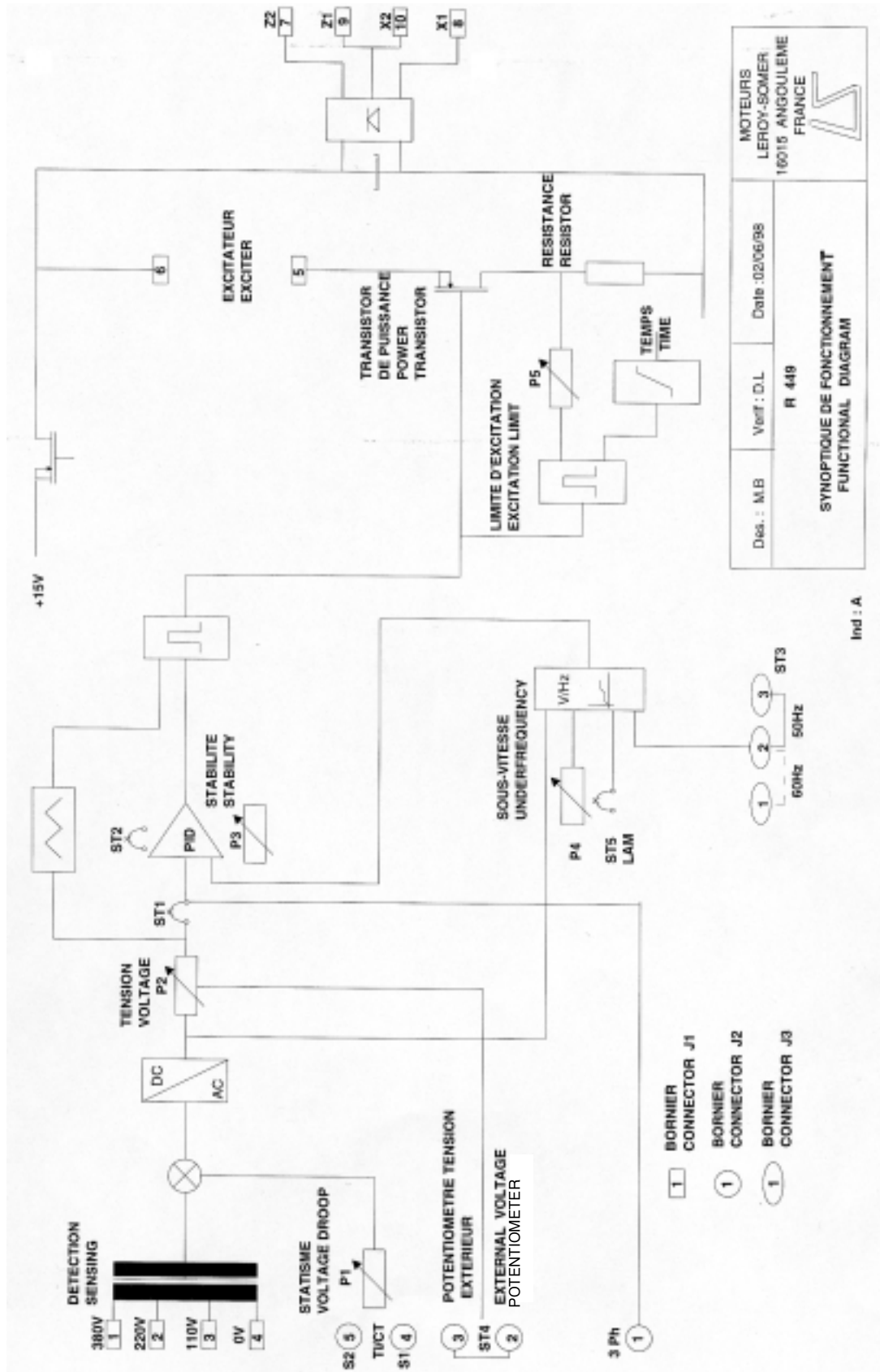

VOLTAGE REGULATOR

R 449

INTRODUCTION TO THE R 449

1.3.2 - detection

The detection is single-phase and is isolated using an internal transformer.

Sensing VA: 5VA

J1 connector, input voltages:

Terminals 0-110V voltage range from 85 to 130V

Terminals 0-220V voltage range from 170 to 260V

Terminals 0-380V voltage range from 340 to 520V

1.3.3 - voltage accuracy

The voltage accuracy is +/- 1%Un, steady state, linear load.

1.3.4 - voltage adjustment

The voltage is adjusted either using an internal potentiometer P2, with a voltage range of +/- 10%Un, or using an external potentiometer (as an option).

The voltage is minimum when internal potentiometer P2 has been rotated fully anti-clockwise.



Connecting the external potentiometer:

External potentiometer 470Ω 3W: Voltage range +/- 5%Un

External potentiometer 1kΩ 3W: Voltage range +/- 10%Un

(option). Remove jumper ST4 and connect the external potentiometer as shown in the diagram below. If a regulator is built into the terminal box, remove jumper ST10 from terminal block C and connect the external potentiometer.

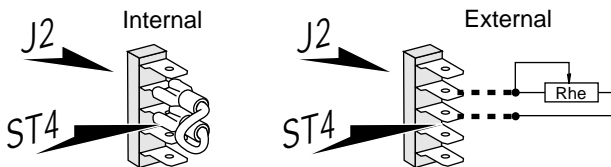

Voltage setting : ST4
A.F. = Internal

1.3.5 - power supply

The power can be supplied:

using 2 independent auxiliary windings integrated in the alternator stator (AREP excitation)

using a single or 3-phase power VT

or using a single or 3-phase PMG.

The single or 3-phase voltage must not exceed 240V AC.

1.3.6 - output power

The output power is 7A 63V under normal conditions and 15A for 10s under overload conditions.

1.3.7 - quadrature droop (1F)

Quadrature droop is achieved using a parallel operation CT (In/1A, 10VA CI1).

The voltage droop can be adjusted using potentiometer P1.

The voltage range is 5%Un for Pn PF 0.8.

The quadrature droop is at 0 when potentiometer P1 has been rotated fully anti-clockwise.

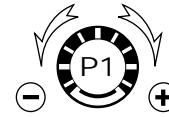

1.3.8 - frequency/underspeed

Selection of underfrequency threshold using the ST3 jumper

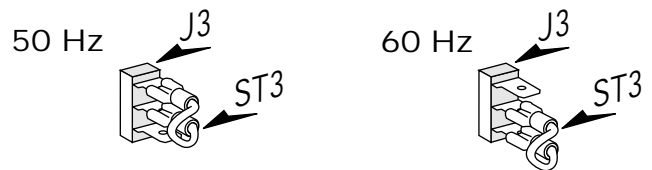

U/F: Action threshold adjustable using potentiometer P4

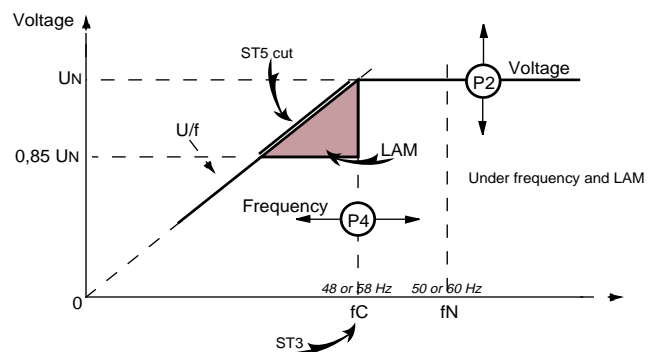

LAM:

When it leaves the factory, the regulator is configured with the LAM activated.

It is disabled by disconnecting the ST5 jumper, and operation is then the standard V/Hz.

- Role of the "LAM" (load adjustment module).

When a load is applied, the speed of rotation of the generator decreases. If the speed falls below the preset frequency threshold, the "LAM" reduces the voltage by approximately 15%. This in turn reduces the active load scale applied by 25% until the speed returns to its rated value.

The "LAM" can therefore either be used to reduce the speed variation (frequency) and its duration for a given applied load, or to increase the possible applied load for the same speed variation (turbo-charged engines).

To avoid voltage oscillations, the trip threshold of the "LAM" function must be set approximately 2Hz below the lowest frequency in normal operation. (Adjustable using potentiometer P4).

- Typical effects of a "LAM" with a diesel engine.

VOLTAGE REGULATOR

R 449

INTRODUCTION TO THE R 449

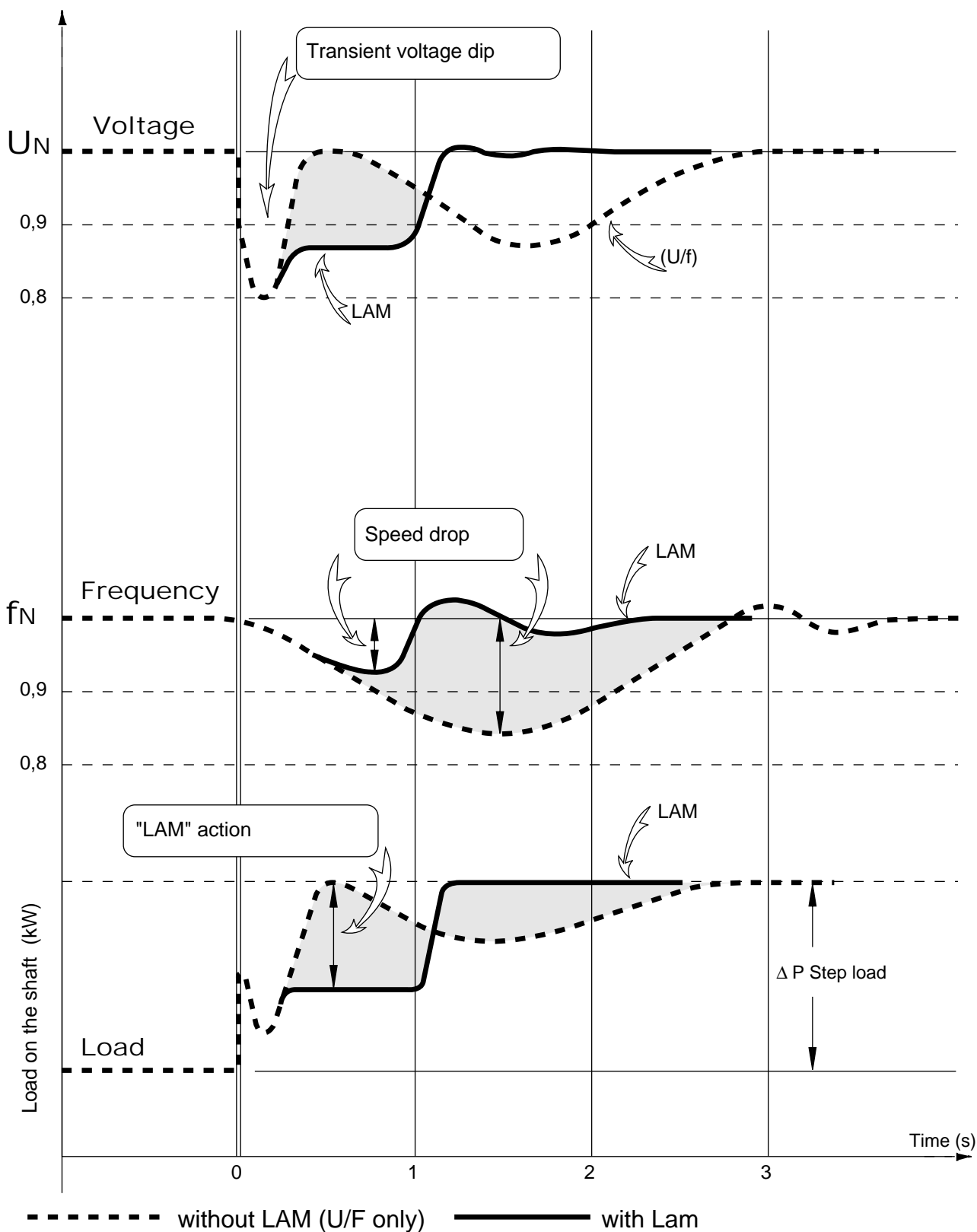

VOLTAGE REGULATOR

R 449

INTRODUCTION TO THE R 449

1.3.9 - stability

The stability and the response time of the alternator can be adjusted using potentiometer P3.
 Presetting P3 for different types of alternator:

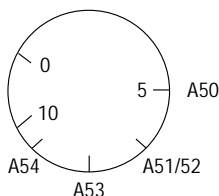

The ST2 jumper modifies the stability. It is closed as standard. Removing this jumper can in some cases improve the response time of the alternator (contact Leroy-Somer).

1.3.10 - limiting the excitation current iex

- The potentiometer P5 is used to adjust the limitation of excitation Amp. Limitation of the excitation current is active for 10s. After this period of time, the excitation current is limited to 2A. The maximum limitation is 15A.

The minimum limitation is when the potentiometer has been rotated fully anti-clockwise.

In the absence of specification to the contrary, P5 is positioned at the clockwise limit.

- Static adjustment of the maximum excitation current
 For this value, the static adjustment is possible when the alternator is stopped, which will not endanger the alternator or the installation.

Disconnect the power supply wires X1, X2 and Z1, Z2 and the alternator voltage reference (terminal strip J1).

Connect the power supply, 200 to 240V, as shown (X1 and X2: 0-220V). Install a 20 ADC ammeter in series with the exciter field.

Turn P5 fully anti-clockwise, switch on the power supply (circuit breaker A).

If the regulator does not discharge, turn potentiometer P2 (voltage) clockwise until the ammeter indicates a stabilised current.

Switch the power supply off and then on again, turn P5 clockwise until the required excitation current is reached (limited to 15A), (for precise adjustment contact Leroy-Somer).

Checking the internal protection:

Open the circuit breaker (D): the excitation current must rise to its preset upper limit, maintain this value for 10s and fall back automatically to a value less than 2A.

To reset, switch off the power supply using the circuit breaker (A).

Note: After setting the upper excitation limit using this procedure, re-adjust the voltage.

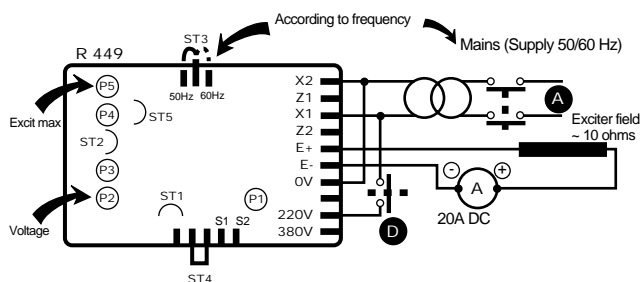

1.3.11 - protection

There are two fuses in the power section. They are mounted externally to the AVR but inside the alternator terminal box.
 Rating: gG 10/38 16A 500V

1.3.12 - voltage build-up

The voltage build-up is automatic (no overvoltage) from the residual magnetism.

If there is no voltage build-up, a short pulse of continuous isolated voltage (12VDC), will usually remedy this. Otherwise, proceed in accordance with the diagram below to re-establish the residual magnetism:

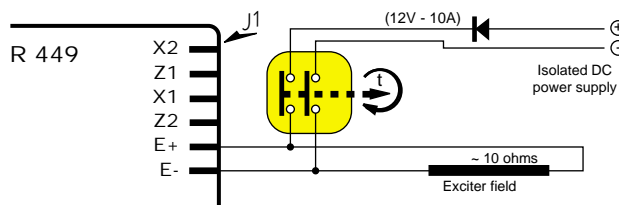

1.3.13 - power used

The power used by the R 449 is 30W, when the alternator is at rated power.

1.3.14 - de-energising

The regulator is de-energised by switching off the voltage regulation power supply.

Contact rating: 15A, 250V AC

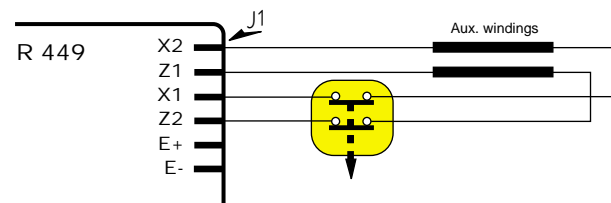

1.4 - environment

- Operating temperature: - 20°C to +70°C
- Storage temperature: - 55°C to + 85°C
- Shocks on the base: 9g for the 3 right-angled directions
- Vibrations: Less than 10Hz: 2mm half peak amplitude
 10Hz to 100Hz: 100mm/s
 Above 100Hz: 8g

VOLTAGE REGULATOR

R 449

R 726: REGULATION OF POWER FACTOR (2F) AND MAINS SENSING (3F)

2 - R 726: REGULATION OF POWER FACTOR (2F) AND MAINS SENSING (3F)

The power factor and mains sensing are done by the R726 module.
See the specific manual.

2.1 - operating diagram

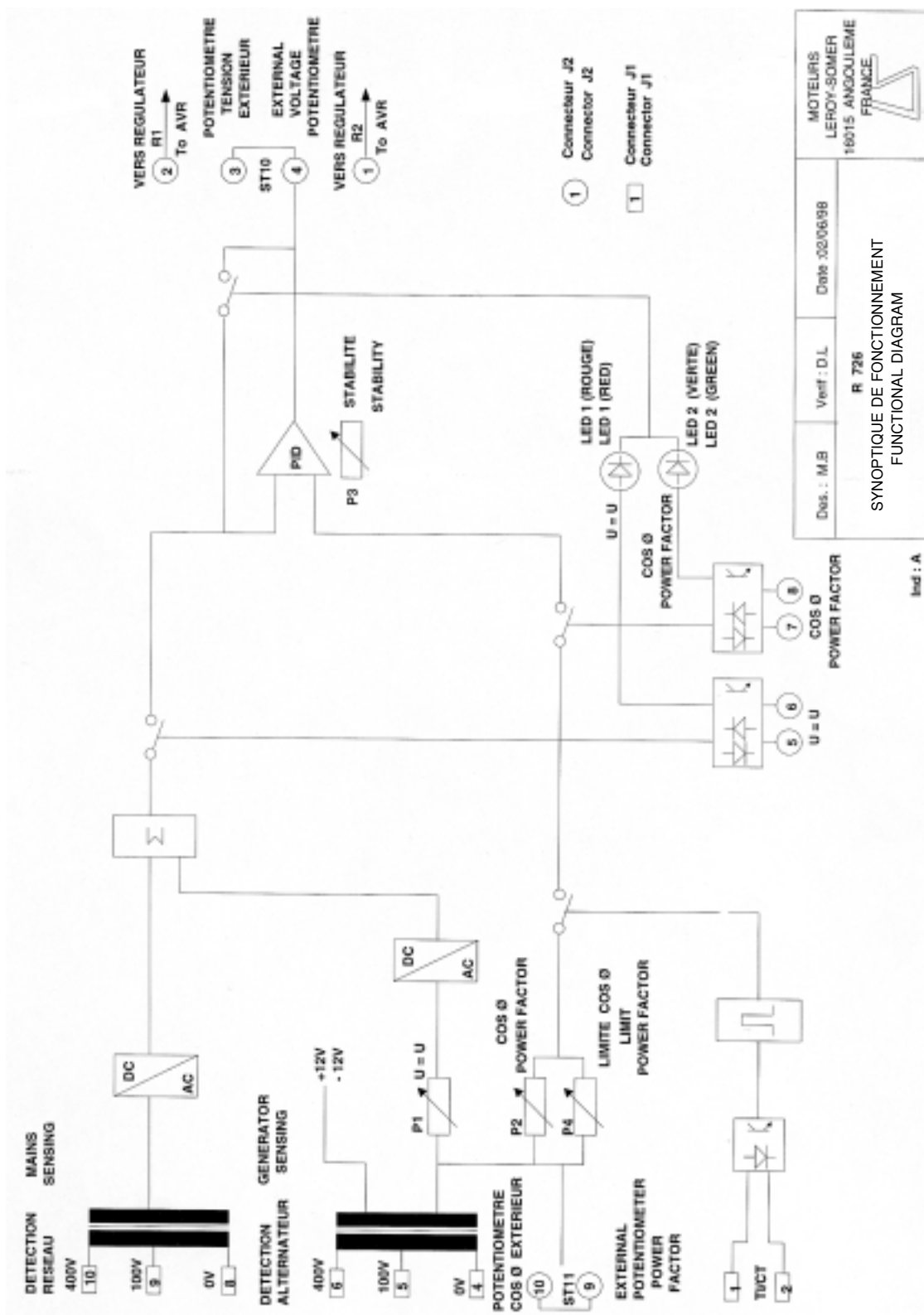

VOLTAGE REGULATOR

R 449

R 726: REGULATION OF POWER FACTOR (2F) AND MAINS SENSING (3F)

2.2 - potentiometers

P1: Potentiometer for adjusting the alternator voltage to the mains voltage (operating mode 3F).

P2: Adjustment of the power factor

P3: Stability

P4: Limitation of the power factor

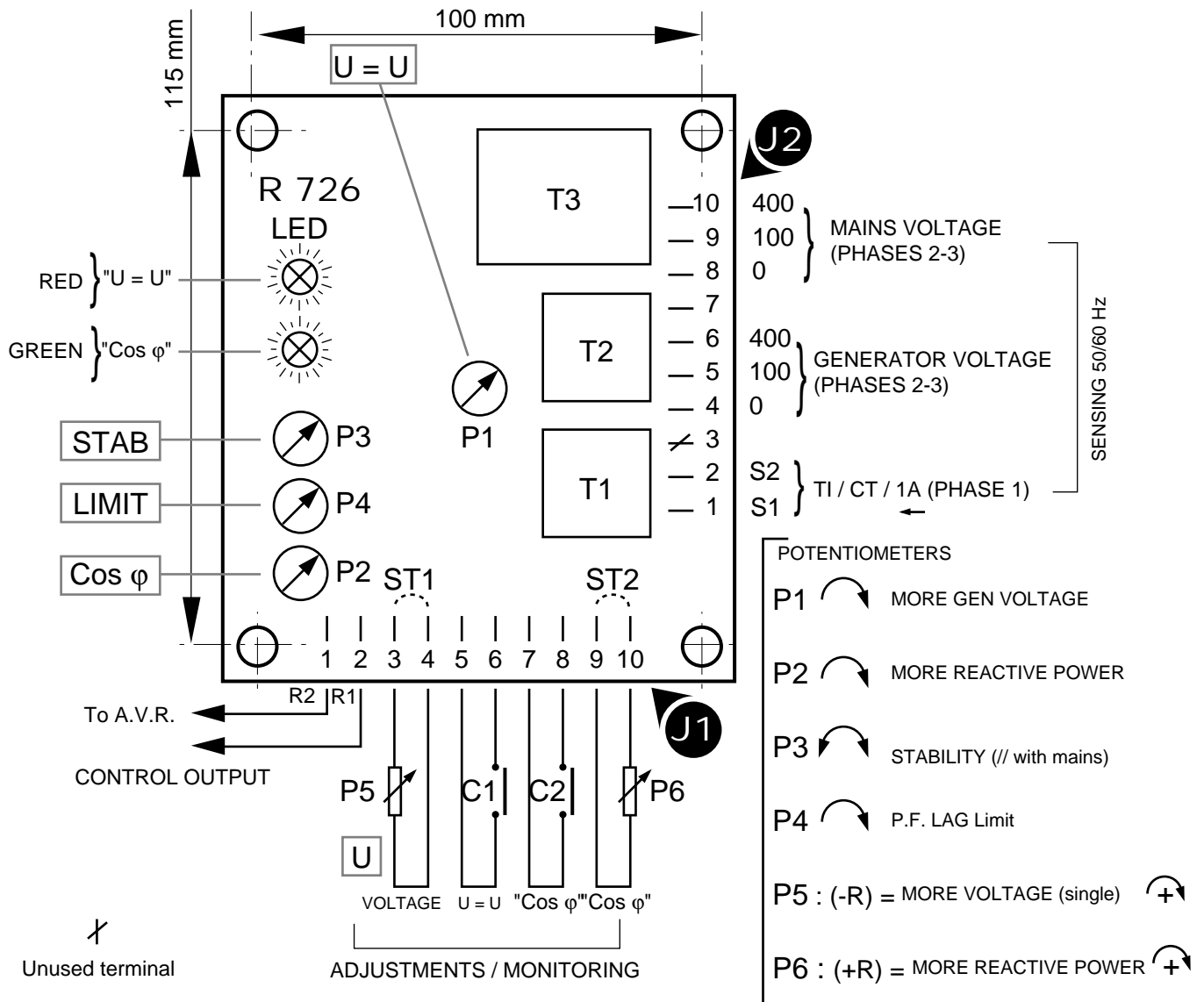

VOLTAGE REGULATOR

R 449

TYPICAL DIAGRAMS

3.2 - AREP 1F 1MV excitation

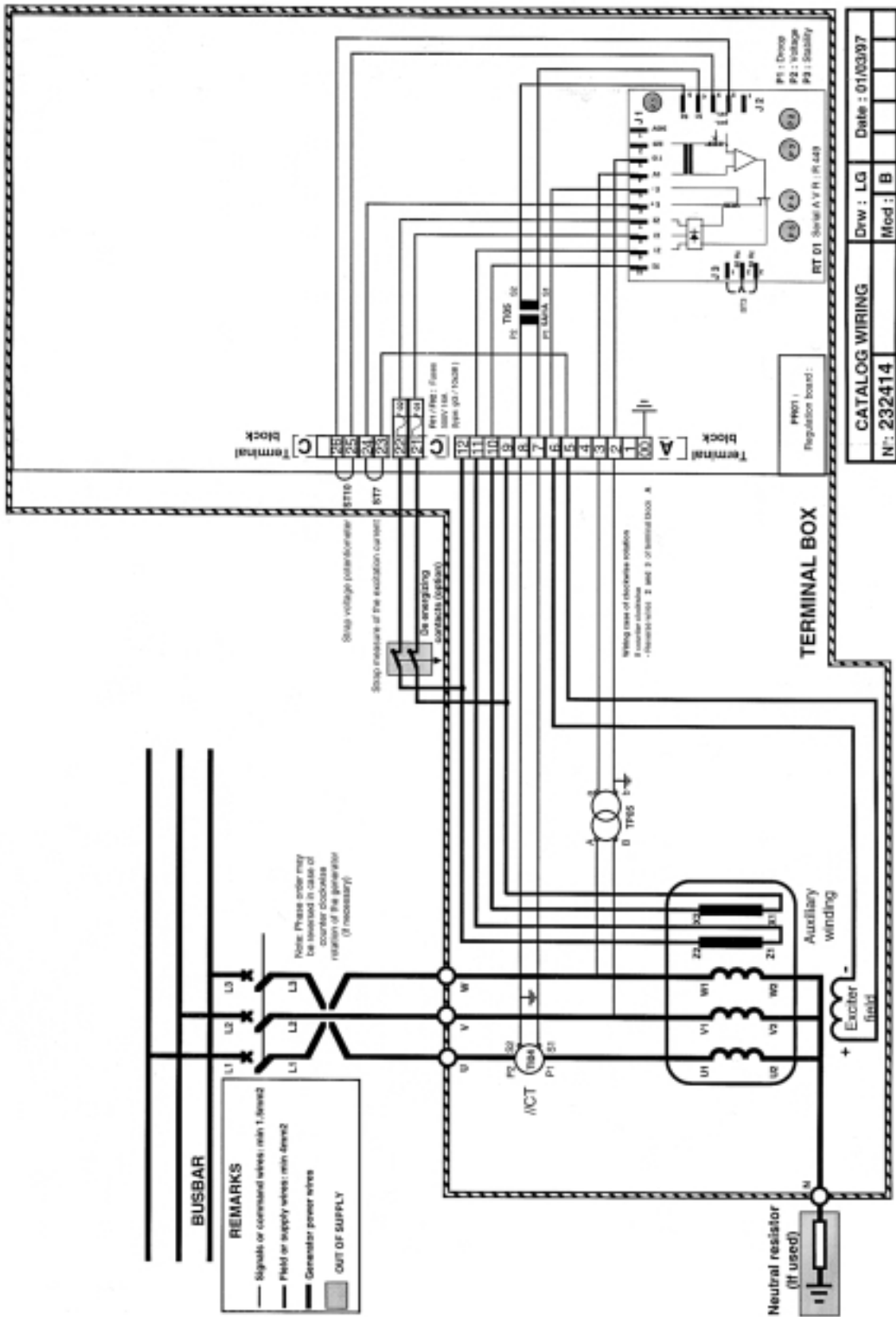

VOLTAGE REGULATOR

R 449

TYPICAL DIAGRAMS

3.3 - AREP 3F LV excitation

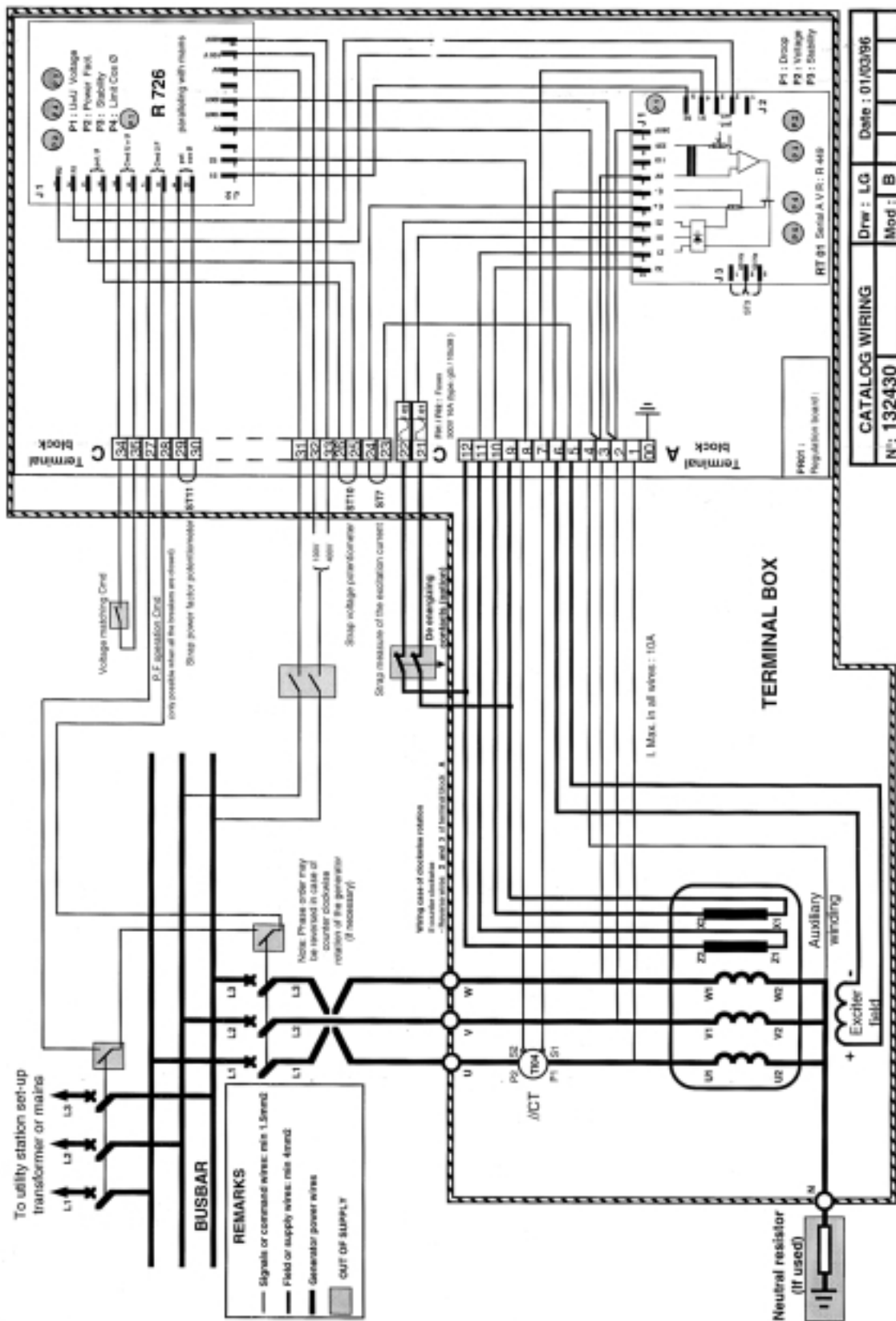

VOLTAGE REGULATOR

R 449

TYPICAL DIAGRAMS

3.4 - AREP 3F MV excitation

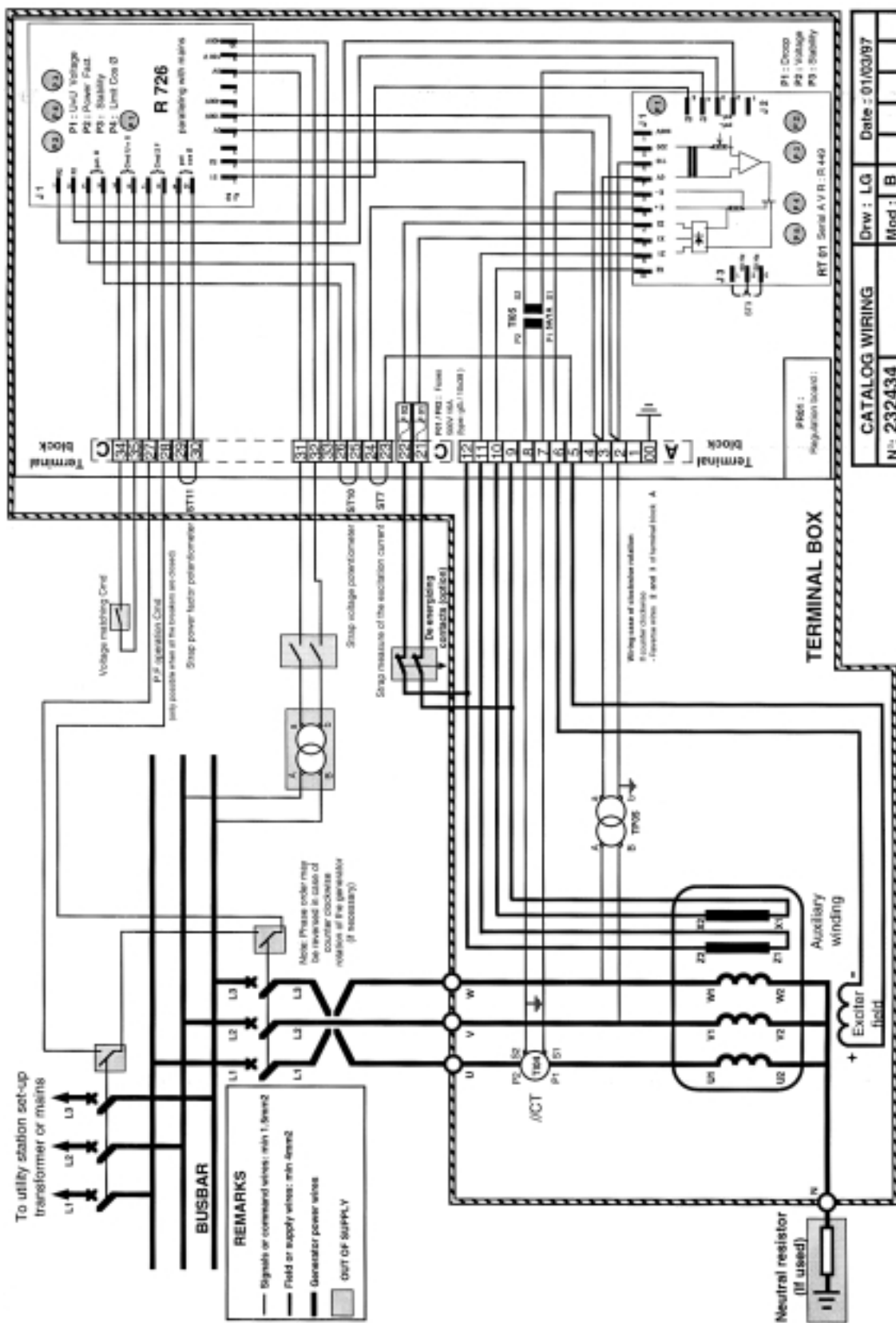

| | | | |
|----------------|--|----------|-----------------|
| CATALOG WIRING | | Drw : LG | Date : 01/03/97 |
| N° : 232434 | | Mod : B | |

VOLTAGE REGULATOR

R 449

TYPICAL DIAGRAMS

3.5 - 1F LV Shunt + Booster excitation

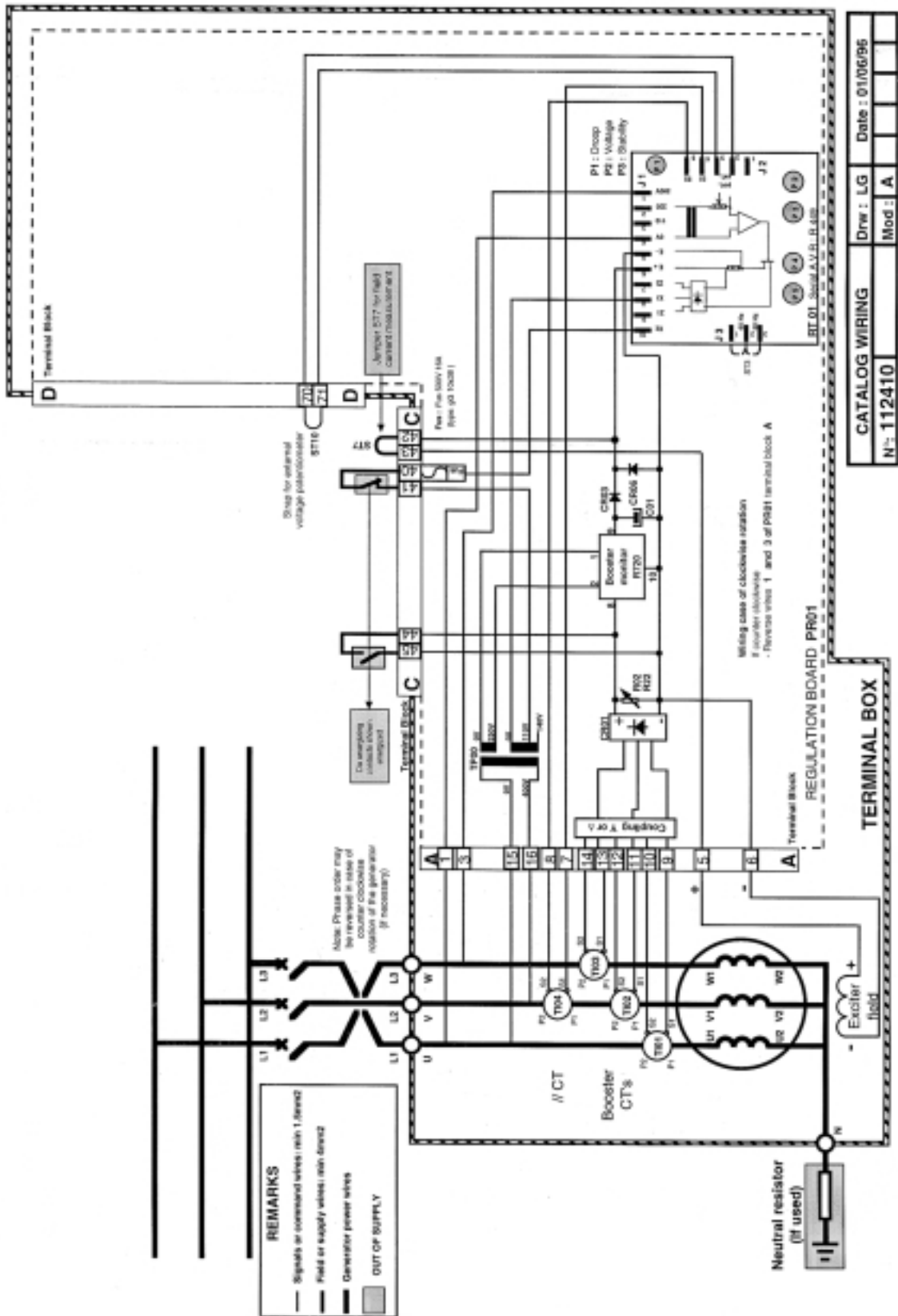

VOLTAGE REGULATOR

R 449

COMMISSIONING

4 - COMMISSIONING

The commissioning principle is the same whatever is the type of excitation.

4.1 - in case of standalone regulation

- Check fuses F1 and F2 which are situated on terminal block C in the alternator.
- Check the regulator:
- Check the position of the ST3 jumper (select the frequency, 50 or 60Hz).
- If an external voltage potentiometer is used, disconnect it from the regulator and install the ST4 jumper (regulator terminal block J2) or the ST10 jumper, terminal block C in the alternator terminal box.
- Turn the internal voltage potentiometer P2 on the regulator fully anti-clockwise.
- Set the alternator to its rated speed using the drive system.
- The alternator voltage should rise to a value of 85 to 90%Un.
- Adjust the voltage to the required value using potentiometer P2.
- Turn potentiometer P1 fully anti-clockwise.
- Perform an on-load test with power factor = 0.8 or power factor = 1. The voltage should remain constant within the limits of the regulator. If it is not stable, see section 13-9.
- Stop the alternator and reconnect the external potentiometer, setting it to the centre position.
- Set the alternator to its rated speed then, using the external potentiometer, set the alternator to its rated voltage.
- The regulator set-up phase is now complete.

4.2 - in case of 1f regulation (parallel operation between alternators)

- The previous settings should be made on each alternator.
- Set the quadrature droop potentiometer to the centre position and perform an on-load test.
- With a load at power factor = 1, the voltage does not drop or only drops slightly; with an inductive load, the voltage drops. This voltage drop is set using quadrature droop potentiometer P1.

The no-load voltage is always greater than the on-load

voltage, if the voltage rises, invert the parallel operation CT. The voltage quadrature droop is generally 2 to 3% of the rated voltage.

- The no-load voltages should be identical on all the alternators intended for parallel operation between each other.
- Connect the alternators in parallel at no load.
- Adjust the setting of voltage P2 or the external voltage potentiometer of one of the machines, try to eliminate (or minimise) the circulating stator current between the machines.
- Do not adjust the voltage further.
- Match the kW power with a minimum load of 30% by adjusting the drive system speed.
- Adjust quadrature droop potentiometer P1 on one of the machines to balance or distribute the stator currents.
- If several alternators are in parallel, take one as a reference.

4.3 - in case of 2f (power factor regulation) and 3f (voltage match circuit) (see R726 manual ref. 2440)

- Check the wiring between the R 449 and the R 726. (See the connection diagram).
- Check the information given for the R 726: mains voltage, 2F contact, 3F contact.
- If an external voltage potentiometer is used, disconnect it from the R 726 and add the ST1 jumper (terminals 3 and 4 of J1) or disconnect it from terminals 25 and 26 of terminal block C of the alternator and add the ST10 jumper.
- If an external PF potentiometer is used, disconnect it from the R 726 and add the ST2 jumper (terminals 9 and 10 of J1) or disconnect it from terminals 29 and 30 of terminal block C of the alternator and add the ST11 jumper.
- Perform a 1F test.
The test principle is the same as in the case of 1F regulation.
- Matching the alternator and mains voltages prior to synchronisation (3F):
- If this function is not used, match the voltages by adjusting the voltage potentiometer.
The following settings are for the R 726.
Close the 3F contact (terminals 5 and 6 of J1 of the R 726 or terminals 34 and 35 of terminal block C of the alternator). The red LED lights up. Adjust potentiometer P1 to match the alternator voltage to the mains voltage.
- Power factor regulation with the alternator synchronised with the mains (2F):

VOLTAGE REGULATOR

R 449

COMMISSIONING

The following settings are for the R 726.

When the alternator is in phase with the mains and the mains and alternator voltages are equal, proceed with synchronisation. Contact 2F closes when the circuit breaker is closed. The green LED on the R 726 lights up. Open contact 3F and remove the mains voltage reference.

Preset the PF potentiometer P2 to 5 and limit potentiometer P4 to 3.5.

Without supplying kW power to the mains, the reactive current of the alternator should be at or around 0.

Increase the kW power. When it reaches 50% of the rated power, adjust potentiometer P4 to obtain a PF of 0.9 LAG (inductive) on the alternator. The range is then 0.7 LAG PF (inductive) (P2 turned fully clockwise) to 0.95 LEADING (capacitive) (P2 turned fully anti-clockwise).

Adjust P2 to obtain the required power factor value.

Increase the kW power until it reaches the rated power. The PF should remain constant.

If it becomes unstable, adjust potentiometer P3 on the R 726 or potentiometer P3 on the R 449.

- Stop the alternator and reconnect the external potentiometers.

VOLTAGE REGULATOR

R 449

TROUBLESHOOTING

5 - TROUBLESHOOTING

5.1 - checking the windings and rotating diodes using a separate excitation

During this procedure, you must check that the alternator is not connected to any external loads and examine the terminal box to check that the connections have been made correctly.

- Stop the generator, disconnect and isolate the regulator wires.
- There are two possible assemblies for a separate excitation: see the diagrams below.
- Assembly A: Connect the DC supply (2 batteries in series) in series with a rheostat of approximately 20 ohms/500W and a diode on both field winding wires (5+) (6-)

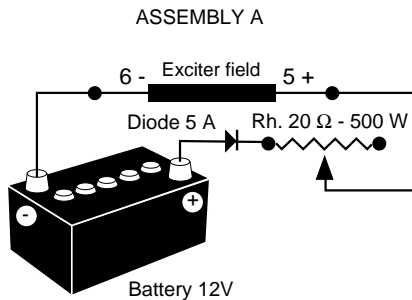

- Assembly B: Connect a "variac" variable power supply and a diode bridge to both field winding wires (5+) (6-).
- These two systems must be compatible with the excitation rating of the machine (see the nameplate).
- Run the generator set at its nominal speed.
- Gradually increase the power supply current of the field winding by adjusting the rheostat or variac and measure output voltages L1, L2, L3, checking the no-load excitation voltages and currents. (See the alternator nameplate or ask Leroy-Somer for the test log).

- If the output voltages are at their rated values and are balanced at < 1% for the given excitation value, the machine is operating correctly and the fault is due to the regulation part (regulator, wiring, sensing, auxiliary windings).

ASSEMBLY B

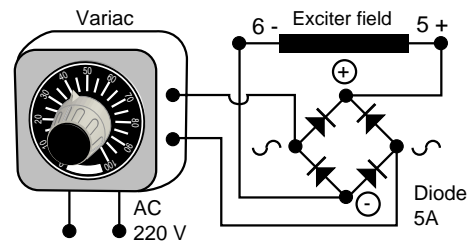

5.2 - static checking of the regulator

If the regulator operates correctly during a static test, this does not necessarily mean that it will operate correctly under real conditions. If the regulator fails the static test, it can be concluded without doubt that the regulator is faulty. Connect a test bulb in accordance with the diagram. The power supply voltage must be between 200 and 240V. The voltage of the bulb is 230V. The power of the bulb will be less than 100W.

- Turn potentiometer P2 fully anti-clockwise.
- Switch the regulator on; the bulb must briefly light up and then go out.
- Slowly turn the voltage potentiometer clockwise, to the right.
- When turned fully clockwise, the bulb lights up continuously.
- At the regulation point, turning the voltage adjustment potentiometer slightly in one direction or the other should make the bulb light up or go out. If the bulb is either lit continuously or does not light up at all, the regulator is faulty.
- Perform one test supplying the regulator via terminals X1 and X2, then another supplying it via terminals Z1 and Z2. Static checking of the LAM: P2 should be positioned where the bulb lights up. Turn potentiometer P4 slowly to the left. The bulb will dim suddenly and the voltage will drop to approximately 85% of the power supply voltage. Return to the P4 starting position. The bulb should light up as brightly as before.

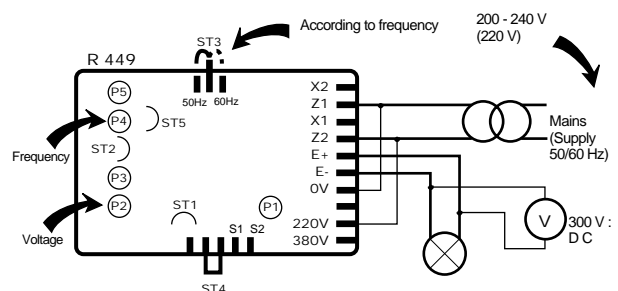

VOLTAGE REGULATOR

R 449

TROUBLESHOOTING

5.3 - troubleshooting table

- Before taking any action on the R 449 or the R 726, pay careful attention to the positions of the potentiometers and the jumpers.

5.3.1 - in case of 1F, parallel operation between alternators

| Symptom | Probable causes | Solutions |
|---|---|---|
| Absence of voltage on start-up, at no load. | <ul style="list-style-type: none"> - No residual magnetism or polarity inversion between the excitation output and the exciter input. - De-energising contacts open. - The speed is less than the rated speed. - Connection lost between the regulator and the exciter. - Alternator loaded or short-circuited. - External potentiometer connected incorrectly - Faulty regulator - Faulty exciter or rotating diode bridge - Fuses blown. | <ul style="list-style-type: none"> - Voltage built-up is required. - Close this contact. - Adjust the speed. - Check the wiring. - Remove the load from the alternator. - Check the wiring. - Test it or change it. - Check the exciter and the diodes. - Replace the fuses. |
| Voltage too high and adjustment potentiometer not operating. | <ul style="list-style-type: none"> - Incorrect voltage at the sensing terminals. - Loss of sensing. - The external potentiometer has an incorrect value. - Faulty regulator. | <ul style="list-style-type: none"> - Check the wiring of the 0, 110V, 220V, 380V terminals on terminal block J1. - Check the wiring. - Set a potentiometer with the correct value. - Test it or change it. |
| Voltage too high, but adjustable by the adjustment potentiometer. | <ul style="list-style-type: none"> - Voltage potentiometer set too high. - Regulator sensing incorrect. - Regulator faulty. | <ul style="list-style-type: none"> - Adjust voltage potentiometer P2 or the external potentiometer. - Check the wiring and the sensing value, at 0V and 110V, 220V, 380V terminals. - Test it or change it. |
| Voltage too low, but adjustable by the adjustment potentiometer. | <ul style="list-style-type: none"> - ST3 and ST4 jumpers. - The speed is too low. - Exciter and rotating diodes. | <ul style="list-style-type: none"> - Check the presence of the ST3 and ST4 jumpers. - Set to the correct speed. - Check the exciter and the rotating diodes. |

VOLTAGE REGULATOR

R 449

TROUBLESHOOTING

| Symptom | Probable causes | Solutions |
|---|---|--|
| Incorrect regulation. | <ul style="list-style-type: none"> - Distortion of the waveform, non-linear load. - Unbalanced load. - The speed is not at the correct value. - Exciter or rotating diodes faulty. - Faulty regulator. | <ul style="list-style-type: none"> - Contact Leroy-Somer. - Balance the load or change the sensing points. - Adjust the speed. - Check the exciter and the rotating diodes. - Test it or change it. |
| Voltage unstable. | <ul style="list-style-type: none"> - Frequency unstable. - Secondary sensing of a transformer supplying other devices. - Stability potentiometer P3 is incorrectly set. - Faulty regulator. | <ul style="list-style-type: none"> - Check the stability of the drive system speed. - Provide separate sensing for the alternator. - Adjust stability potentiometer P3. - Test it or change it. |
| Response time too long. | <ul style="list-style-type: none"> - Stability adjustment. - Speed regulator response too long. | <ul style="list-style-type: none"> - Adjust stability potentiometer P3 and the ST2 jumper. - Adjust the stability of the speed. |
| Considerable drop in voltage, on-load. | <ul style="list-style-type: none"> - Vectorial composition fault between the voltage and the current. - The parallel operation CT ratio is incorrect. | <ul style="list-style-type: none"> - Check the wiring of the sensing and parallel operation CT. - Correct the CT ratio. |
| kVAR not stable between alternators (reactive current circulation). | <ul style="list-style-type: none"> - Quadrature droop potentiometer needs adjusting. - The no-load voltages are not identical. - Phases not connected to the sensing correctly. - The CT is not on the correct phase. | <ul style="list-style-type: none"> - Adjust the quadrature droop potentiometer. - Check that all the alternators have the same no-load voltage value. - Check the sensing wiring. - Check the position of the parallel operation CT. |

VOLTAGE REGULATOR

R 449

TROUBLESHOOTING

5.3.2 - example of 2F and 3F

| Symptom | Probable causes | Solutions |
|---|--|---|
| Incorrect regulation of PF, PF potentiometer not operating. | <ul style="list-style-type: none"> - Vectorial composition fault between the sensing voltage and the stator current. - R 726 faulty. - R 726 ST2 jumper missing. - Wiring fault between the R 449 and the R 726. | <ul style="list-style-type: none"> - Check the sensing wiring and the parallel operation CT. - Change the module. - Check the wiring, in particular the wires between 1 and 2 of terminal block J1 on the R 726. |
| PF range incorrect. | <ul style="list-style-type: none"> - Settings on potentiometers P2 and P4 incorrect. | <ul style="list-style-type: none"> - Reset the range as shown above. |
| The LEDs will not light up. | <ul style="list-style-type: none"> - Contacts 2F and 3F missing. | <ul style="list-style-type: none"> - Check the wiring. |
| Cannot adjust the voltage matching circuit. | <ul style="list-style-type: none"> - The sensing voltage is incorrect or incorrectly connected. | <ul style="list-style-type: none"> - Check the wiring and the value of the voltage. |

5.3.3 - checking the alternator using a separate excitation

- The alternator is tested at no load.
- Disconnect the R 449 and R 726 and the entire excitation system of the alternator.
- Connect a 24V 5A variable DC supply to the exciter field wires.
Apply a direct current to the exciter to obtain the rated voltage.
- Check all the alternator parameters:
Stator voltage, field winding voltage, AREP or regulator power transformer voltages, sensing voltage at the regulator terminal block.
- All these parameters should be checked against the alternator characteristics.

5.4 - replacing the regulator with a spare voltage regulator

- Set the potentiometers and the jumpers in the same way as the original regulator.

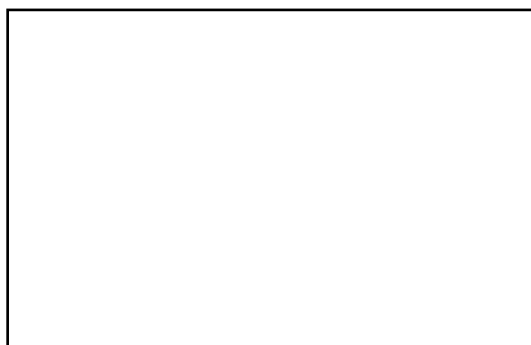

MOTEURS LEROY-SOMER 16015 ANGOULÊME CEDEX - FRANCE

RCS ANGOULÊME N° B 671 820 223
S.A. au capital de 131 910 700 F

<http://www.leroy-somer.com>